

AUTOCOLLIMATORS

90°-VIEWING – WITH RETICLE TURRET

Description:

For a general description of the principle of functioning see page 42.

The autocollimator with reticle turret provides 6 selectable collimator reticles. The reticle turret allows fast switching between different measurement tasks.

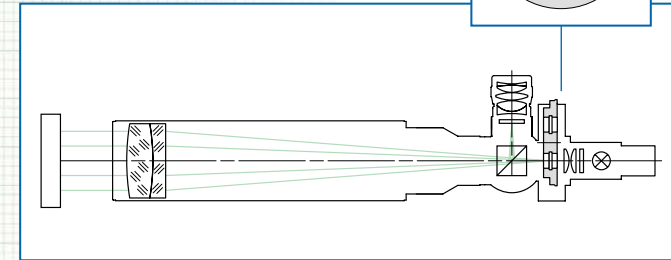
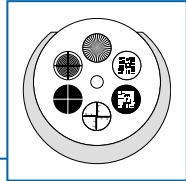

Application areas:

- Measurement of angular tilt
- Testing of the infinity setting of camera objectives
- Qualitative testing of the imaging properties of optical elements and systems
- Fast testing of wedges and plane parallel plates with pinhole diaphragm turret

Notes on ordering:

- Optionally, the autocollimators can be equipped with an eyepiece having 10 mm or 25 mm focal length.
- Reticles, 6V/5W illumination w/cord, and eyepiece are included.
- In contrast to autocollimators with only one collimator and one eyepiece reticle the optical axis can not be adjusted to its mechanical (tube) axis.
- If not specified otherwise, the autocollimator is adjusted to infinity at 546 nm wavelength. Adjustment to other distances or wavelengths is also possible on demand.
- The nomenclature of the autocollimators with 90°-viewing and with reticle turret is as follows:

Example: AK R 50/ 40/ 14,7 SW

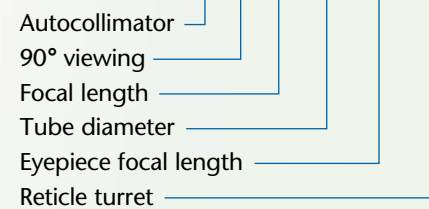

Important:

Please specify six collimator reticles and one eyepiece reticle (see page 82) as well as illumination (LED-, bulb- or cold light, see page 81) when ordering.

Please specify direction of use if reticles with lettering (e.g. coordinate division etc.) are used so that the lettering will be right-side-up.

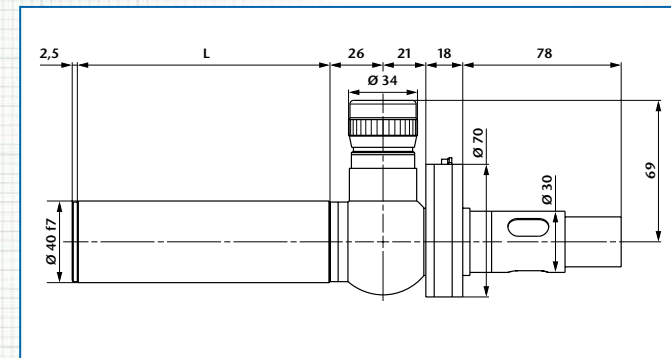

Ord.-No.	Description	Focal length	Free aperture	Meas. range	L
229 281	AKR 50/40/14,7 SW	50	10	5,0°	65
229 282	AKR 90/40/14,7 SW	90	16	3,0°	65
229 283	AKR 140/40/14,7 SW	140	28	2,0°	118
229 284	AKR 200/40/14,7 SW	200	28	1,5°	173
229 285	AKR 300/40/14,7 SW	300	28	1,0°	274
229 286	AKR 500/40/14,7 SW	500	28	0,5°	474

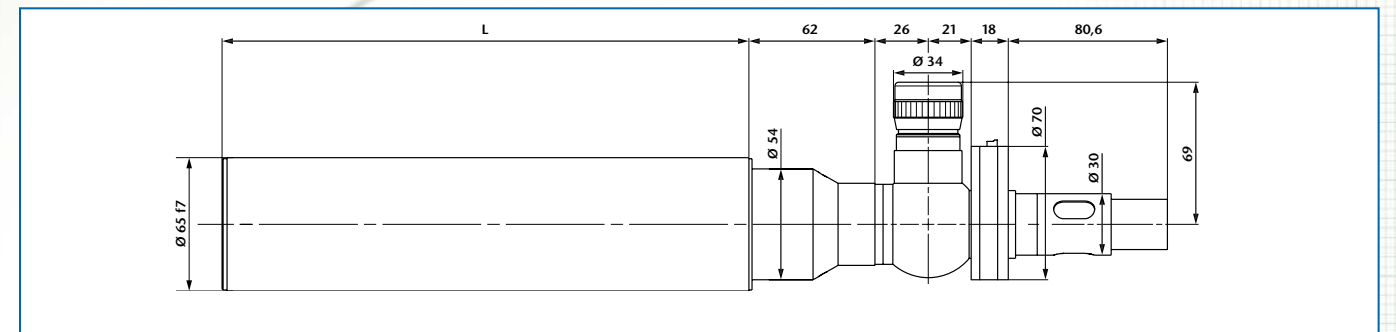

Ord.-No.	Description	Focal length	Free aperture	Meas. range	L
229 287	AKR 300/65/14,7 SW	300	50	1,0°	65
229 288	AKR 500/65/14,7 SW	500	50	0,5°	65
229 290	AKR 500T/65/14,7 SW	500	50	0,5°	118

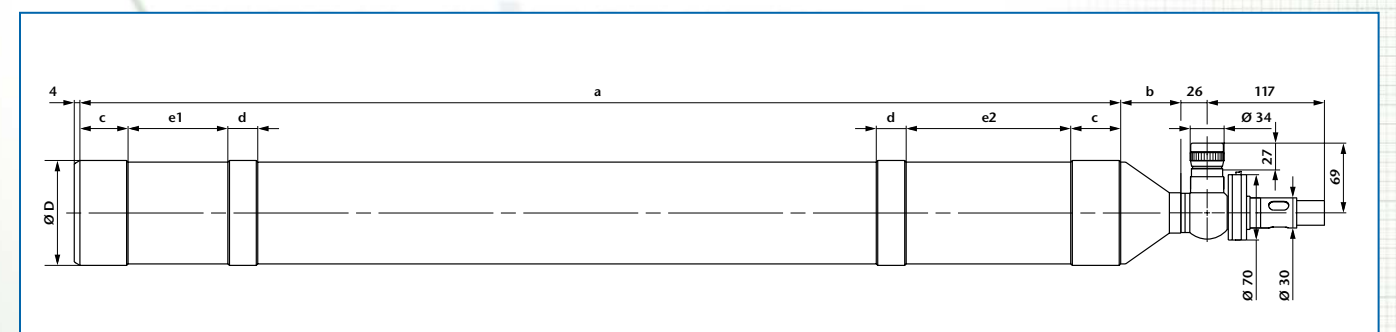
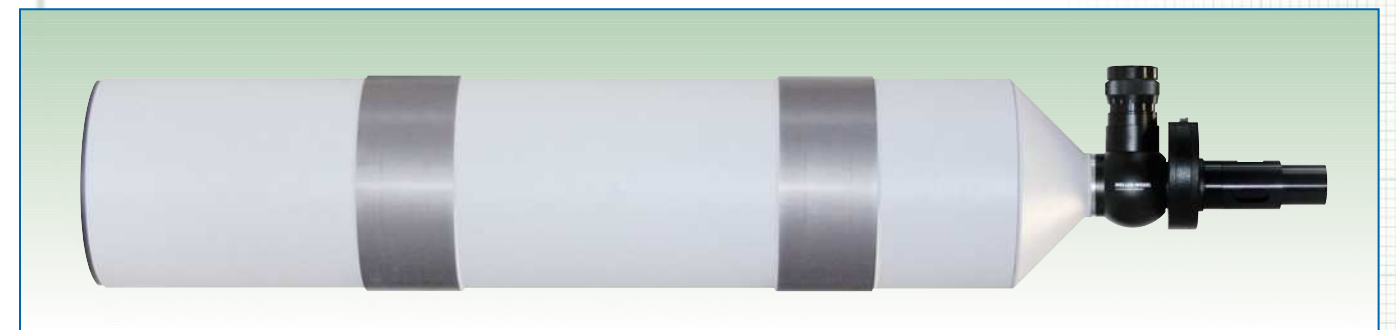

Ord.-No.	Description	Focal length	Free aperture	Meas. range	D	a	b	c	d	e1	e2
229 292	AKR 600/128/14,7 SW	600	100	0,40°	Ø 128 f7	530	46	-	58	154	78
229 293	AKR 1100/105/14,7 SW	1100	78	0,25°	Ø 105 f7	1045	66	50	30	165	100